



Light Stick T

table









ISTRUZIONI DI MONTAGGIO / ASSEMBLY INSTRUCTIONS / INSTRUCTIONS DE MONTAGE / MONTAGEANLEITUNGEN / INSTRUCCIONES DE MONTAJE

I AVVERTENZE

- Si raccomanda che l'installazione venga eseguita da un elettricista abilitato.
- Togliere la tensione di alimentazione prima di effettuare l'installazione e per interventi di manutenzione o in caso di cattivo funzionamento.
- Si consiglia l'utilizzo dei guanti in dotazione. Per la pulizia della superficie utilizzare un piumino rimuovi-polvere.
- La lampada acquistata è garantita se installata e utilizzata nel rispetto delle specifiche del modello. Catellani & Smith declina ogni responsabilità per installazione non appropriata e/o uso diverso da quello indicato.
- La sorgente luminosa di questo apparecchio deve essere sostituita esclusivamente dal produttore, dal suo servizio di assistenza o da personale qualificato equivalente.

GB WARNINGS

- Only a qualified electrician should execute the installation.
- Switch off the power supply before installing, servicing or in case of malfunctioning.
- We suggest you to use the gloves provided. We recommend using a feather duster to clean the surfaces.
- The purchased lamp is guaranteed if installed and used in accordance with the specifications of the model. Catellani & Smith is not responsible for inappropriate installation of the product and/or a different use than the one indicated.
- The lighting source of this appliance must be replaced by the manufacturer, by its technical service or by a qualified electrician.

tensione di rete / voltage		lampadine / bulbs	trasformatore / transformer	dimmer	
110V - 240V		6 x 1W LED @350 mA	plug driver max 18W	incluso	
		6 x 1W LED @350 mA	plug driver max 18W	included	
II classe class	IP20 classe di protezione protection class	 persone suggerite per il montaggio people required for mounting	  ↔ 		
				MADE IN ITALY	

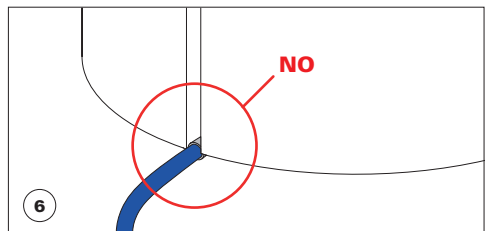
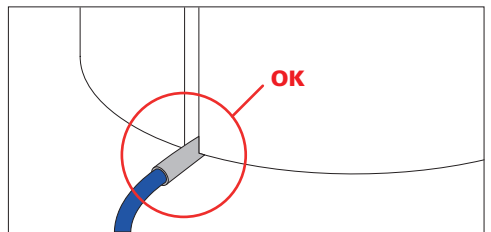
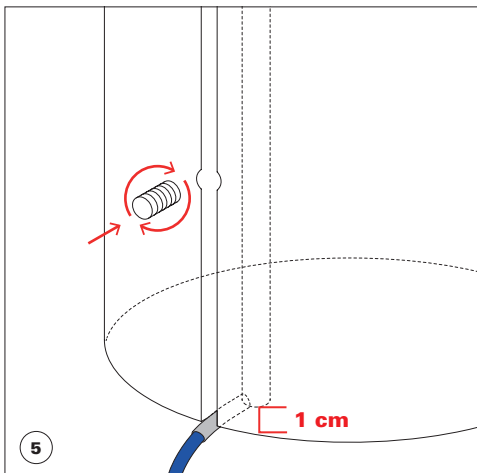
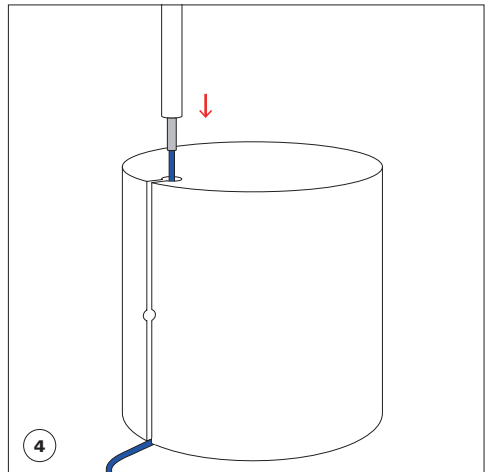
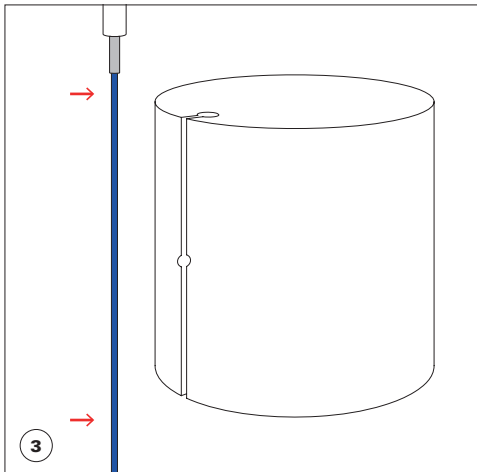
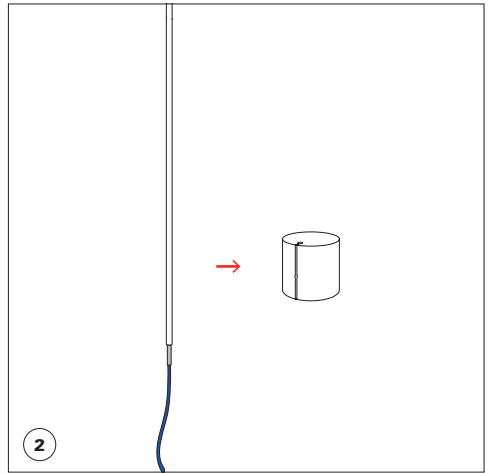
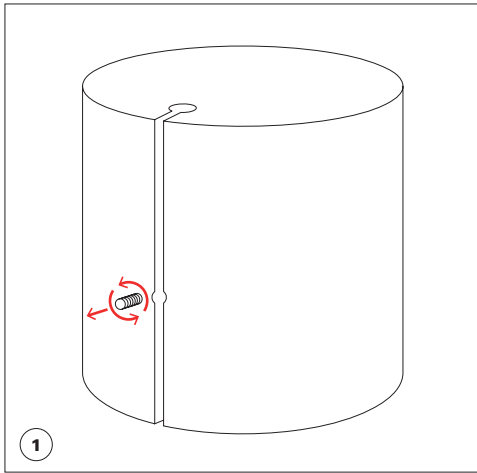

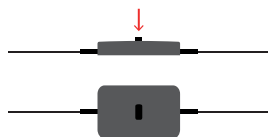

ON/OFF

Premere per accendere e spegnere la luce.
Press to turn on/off the light.

DIMMER

Tener premuto per aumentare o diminuire l'intensità luminosa.
Hold to increase and decrease the light intensity.



A (US)



I (AUS)



G (UK)



C (EU)

ORIENTAMENTO ASTA LED HOW TO ORIENT THE LED BAR

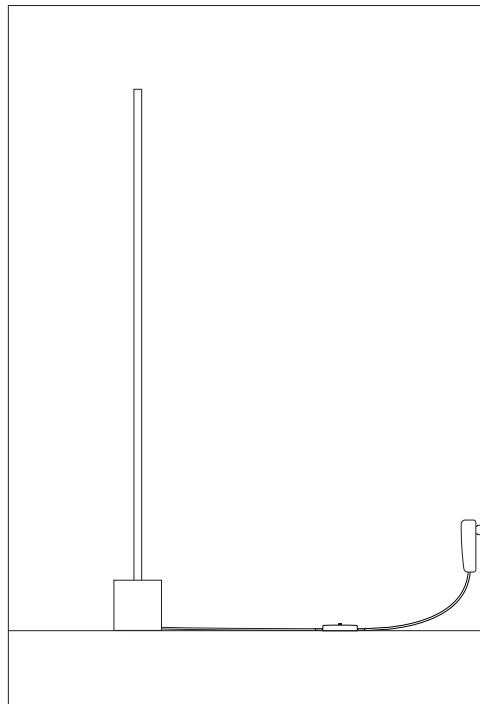
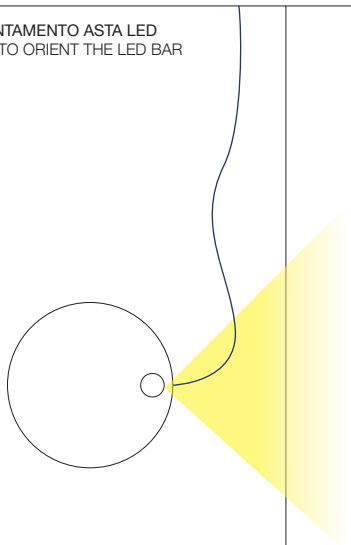

updated 06/2023

Questa apparecchiatura non deve essere smaltita come un normale rifiuto urbano, ma deve essere portata nel punto di raccolta appropriato per il riciclaggio di apparecchiature elettriche ed elettroniche. Provvedendo a smaltire questo prodotto in modo appropriato, si contribuisce ad evitare potenziali conseguenze negative per l'ambiente e per la salute umana, che potrebbero derivare da uno smaltimento inadeguato del prodotto. Per informazioni più dettagliate sul riciclaggio di questo prodotto, contattare l'ufficio comunale, il servizio locale di smaltimento rifiuti o il rivenditore presso il quale è stato acquistato il prodotto.

This equipment may not be treated as household waste. Instead it shall be handed over to the applicable collection point for the recycling of electrical and electronic equipment. By ensuring this product is disposed of correctly, you will help prevent potential negative consequences for the environment and human health, which could otherwise be caused by inappropriate waste handling of this product. For more detailed information about the recycling of this product, please contact your local city office, your household waste disposal or the dealer where you purchased this product.

