



Catellani & Smith®

More

pendant / outdoor



ISTRUZIONI DI MONTAGGIO / ASSEMBLY INSTRUCTIONS / INSTRUCTIONS DE MONTAGE / MONTAGEANLEITUNGEN / INSTRUCCIONES DE MONTAJE

I AVVERTENZE

- Si raccomanda che l'installazione venga eseguita da un elettricista abilitato.
- Togliere la tensione di alimentazione prima di effettuare l'installazione e per interventi di manutenzione o in caso di cattivo funzionamento.
- Se il cavo di alimentazione esterno viene danneggiato, deve essere sostituito esclusivamente dal costruttore o dal suo servizio di assistenza.
- Tutti i nostri prodotti in finitura grezza sono sensibili agli agenti esterni. È possibile quindi la comparsa di ruggine in modo disomogeneo.
- La lampada acquistata è garantita se installata e utilizzata nel rispetto delle specifiche del modello. Catellani & Smith declina ogni responsabilità per installazione non appropriata e/o uso diverso da quello indicato.
- La sorgente luminosa di questo apparecchio deve essere sostituita esclusivamente dal produttore, dal suo servizio di assistenza o da personale qualificato equivalente.

GB WARNINGS





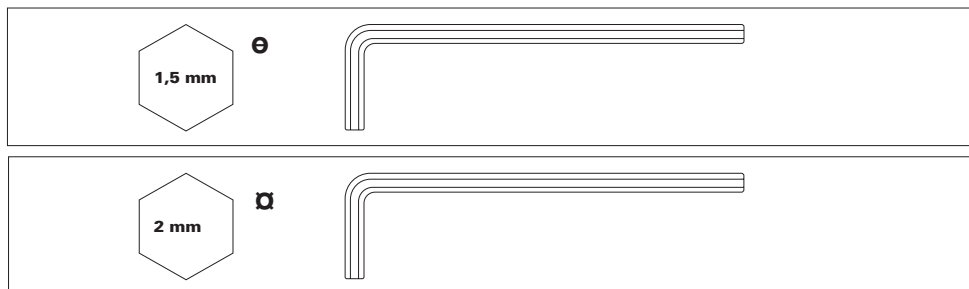

- Only a qualified electrician should execute the installation.
- Switch off the power supply before installing, servicing or in case of malfunctioning.
- In case the supply cable of the lamp would be damaged, it has to be replaced exclusively by the manufacturer or by his technical service.
- All our rough-finished products are sensitive to external agents. It is therefore possible that uneven patches of rust appear.
- The purchased lamp is guaranteed if installed and used in accordance with to the specifications of the model. Catellani & Smith is not responsible for inappropriate installation of the product and/or a different use than the one indicated.
- The lighting source of this appliance must be replaced by the manufacturer, by its technical service or by qualified electrician.

*Specifiche IP: portalampada IP65 (non adatto a immersione); cavi e connessioni IP68.

*IP Specifics: lamp holder IP65 (not protected against immersion); wires and connectors IP68.

UTENSILI INCLUSI / TOOLS SUPPLIED



tensione di rete / voltage		lampadine / bulbs	alimentatore / driver	dimmerazione / dimming	
-		1x G4 max 1W LED 12V DC	driver a tensione costante - non incluso	-	
		1x G4 max 1W LED 12V DC	constant voltage driver - not included	-	
III classe class	IP65* classe di protezione protection class	 persone suggerite per il montaggio people required for mounting	  ↔ 		
MADE IN ITALY					

WARNING

12V connection

Driver non incluso/ non connettere 110V/230V direttamente!

Driver not included/ Do not connect to 110V/230V directly!

nodo consigliato /
recommended knot



1

CAVO ACCIAIO
STEEL CABLE

dettaglio non incluso /
detail not included

12V

2

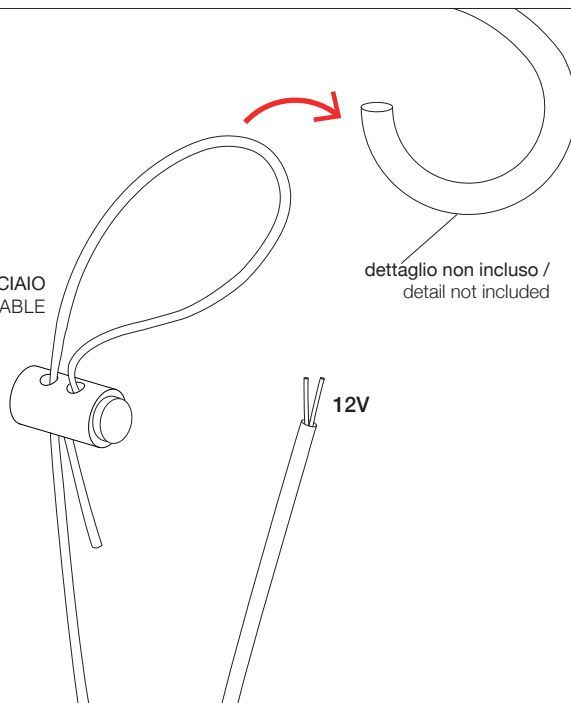

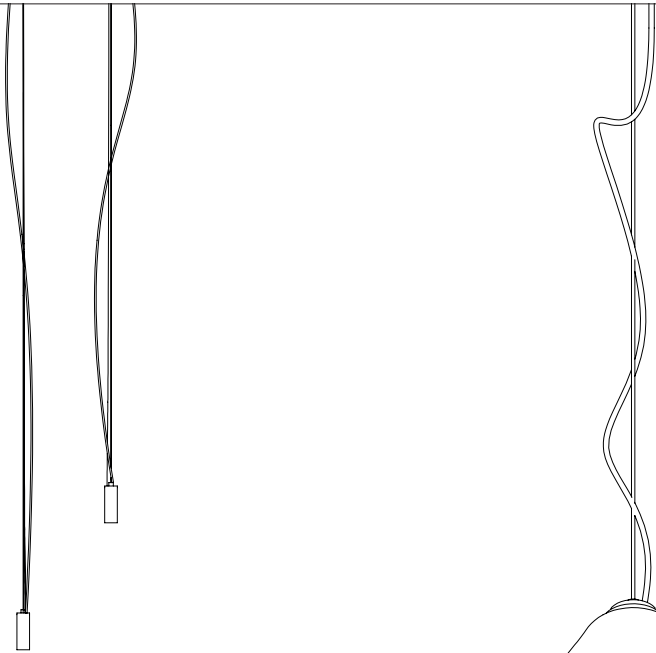

montaggio lampadina, vetro delicato
bulb mounting, fragile glass

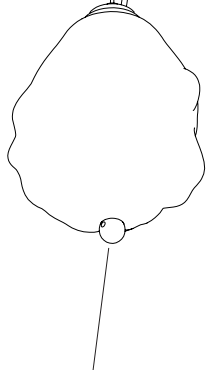
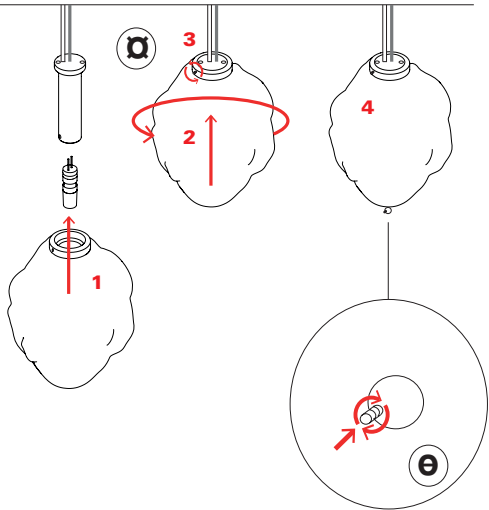

sfera di sicurezza /
safety sphere

ISTRUZIONI PER CONNESSIONE SINGOLA LAMPADA
INSTRUCTIONS FOR THE CONNECTION OF A SINGLE LAMP

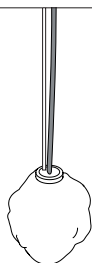

L1

Driver e mini gel box disponibili a richiesta
Driver and mini gel box available on request

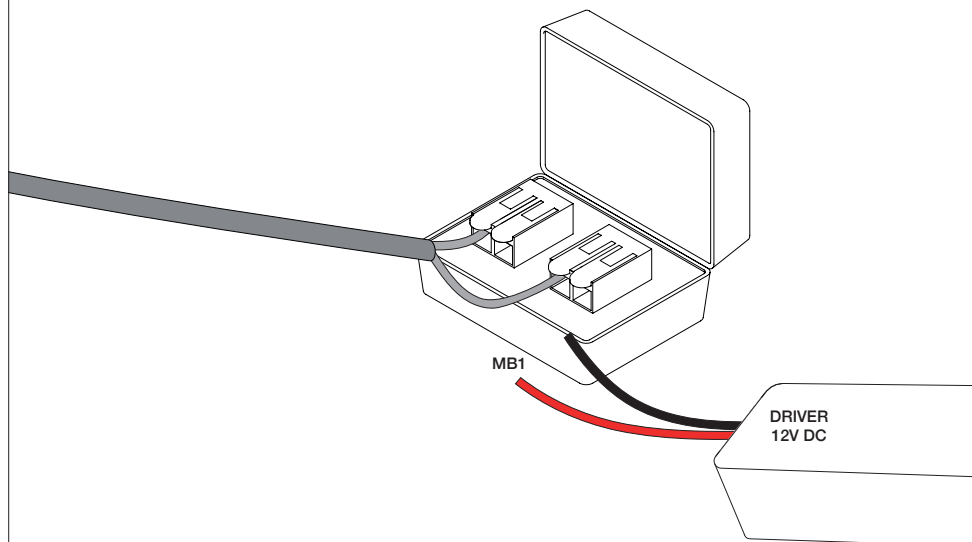

4

ISTRUZIONI PER CONNESSIONE MULTIPLA LAMPADE
INSTRUCTIONS FOR THE CONNECTION OF MULTIPLE LAMPS

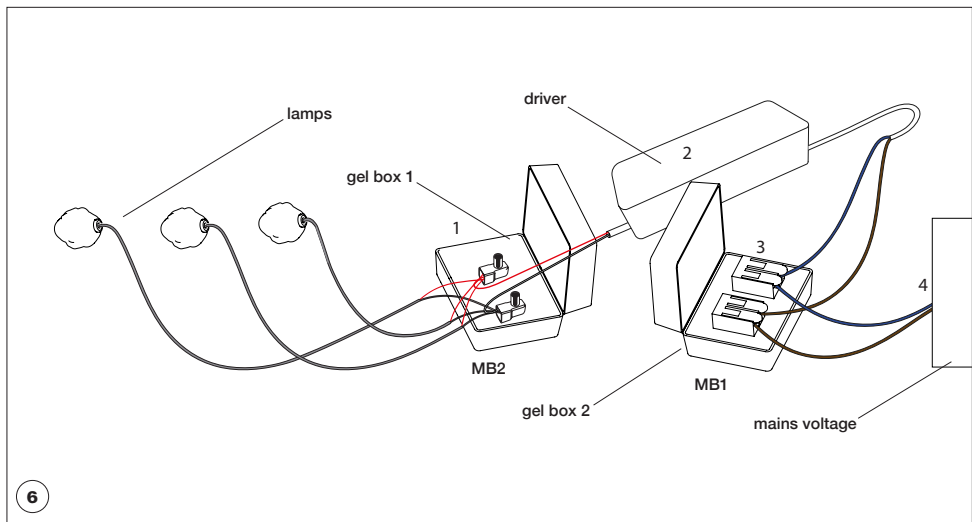
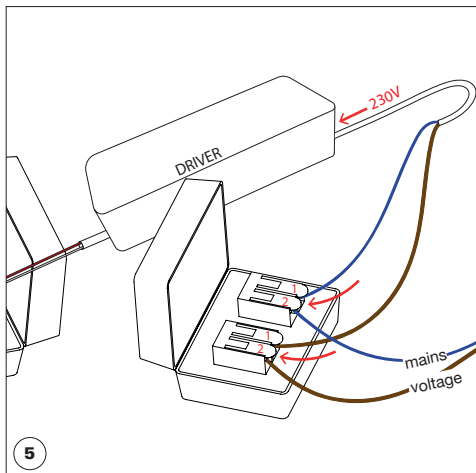
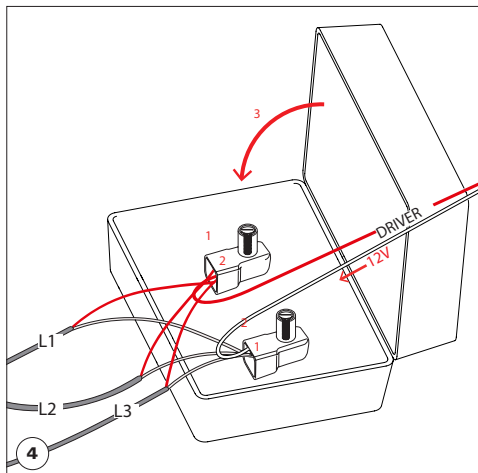
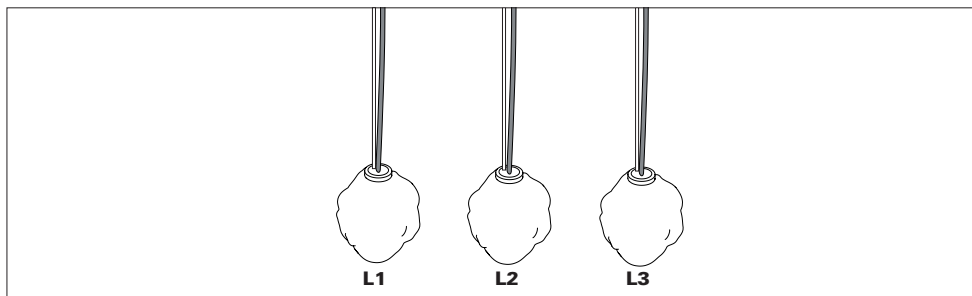

montaggio e sostituzione lampadina / bulb mounting and replacement

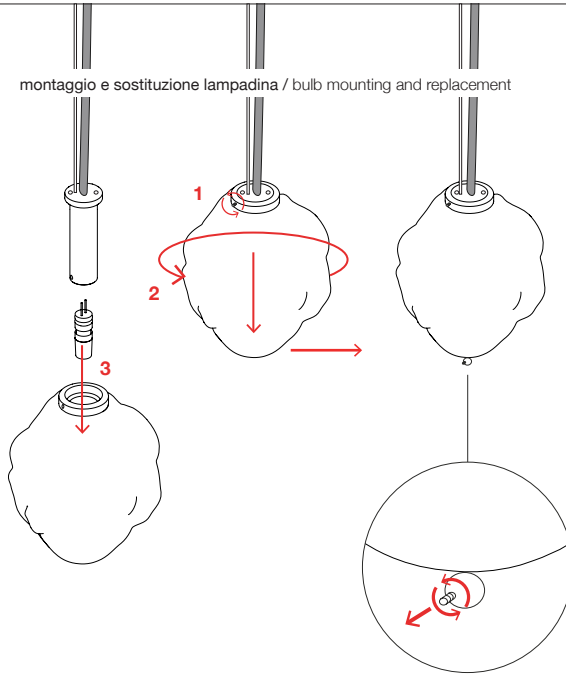

ATTENZIONE

vetro delicato - maneggiare con cura

WARNING

fragile glass - handle with care

updated 02/2024

Questa apparecchiatura non deve essere smaltita come un normale rifiuto urbano, ma deve essere portata nel punto di raccolta appropriato per il riciclaggio di apparecchiature elettriche ed elettroniche. Provvedendo a smaltire questo prodotto in modo appropriato, si contribuisce ad evitare potenziali conseguenze negative per l'ambiente e per la salute umana, che potrebbero derivare da uno smaltimento inadeguato del prodotto. Per informazioni più dettagliate sul riciclaggio di questo prodotto, contattare l'ufficio comunale, il servizio locale di smaltimento rifiuti o il rivenditore presso il quale è stato acquistato il prodotto.

This equipment may not be treated as household waste. Instead it shall be handed over to the applicable collection point for the recycling of electrical and electronic equipment. By ensuring this product is disposed of correctly, you will help prevent potential negative consequences for the environment and human health, which could otherwise be caused by inappropriate waste handling of this product. For more detailed information about the recycling of this product, please contact your local city office, your household waste disposal or the dealer where you purchased this product.

